

# **GR**Reddy®

## ***GR*Reddy Intercooler Kit**

**Type 24 V-SPEC**

**Front-Mounted Intercooler for  
Mazda RX-7 (FD3S) Stock Twin Turbo**



## Mazda RX-7 (FD3S) Stock Twin Turbo

# Installation Manual

**Please read the entire manual before installing this kit.**

Application:

<b>Make</b>	<b>Model</b>	<b>Chassis</b>	<b>Year</b>
<b>Mazda</b>	<b>RX-7</b>	<b>FD3S</b>	<b>93-96</b>

- This **GReddy Intercooler Kit** is designed only for the vehicles specified above with the **Mazda RX-7 (FD3S) Stock Twin Turbo**.
- Installation of this kit requires the use of GReddy Airinx air filter system for FD3S. (other aftermarket air filter system might require modification for proper fitment)
- Installation of this kit requires the use of a smaller battery (size shown below) or relocation of the battery to the trunk.
- Battery size: 197mm X 129mm X 210mm or smaller

# 1. Parts List

1.	Intercooler	(Type 24)		1
2.	Intercooler pipe I-1	(Aluminum 70Ø)		1
3.	"	I-2	(Aluminum 60Ø)	1
4.	"	I-3	(Aluminum 70Ø)	1
5.	"	I-4	(Aluminum 70Ø)	1
6.	Rubber Hose	70Ø X 70mm		5
7.	Reducer Hose	70Ø - 80Ø		1
8.	Hose Band	38Ø #24	(Water line)	4
9.	"	#40	(A/C Tank)	1
10.	"	70Ø #44		11
11.	"	80Ø #48		1
12.	Water Tube	A	(38Ø Steel)	1
13.	"	B	(38Ø Steel)	1
14.	P/S Cooler tube	(12Ø Steel)		1
15.	A/C condenser bracket	A		2
16.	"	B		1
17.	Radiator bracket	A		1
18.	"	B		1
19.	"	C		2
20.	P/S Cooler tube bracket			3
21.	Battery bracket			1
22.	Aluminum spacer	t=20		2
23.	Battery terminal spacer			1
24.	Zip Ties	150mm		5
12.	M6 X 15	P=1.0	Stainless B S/W F/W N	4
13.	M6 X 15	P=1.0	Stainless B S/W F/W -	5
12.	M6		Stainless - S/W F/W N	3
13.	Tapping Screw			1
12.	M6 X 30	P=1.0	Steel B S/W F/W N	2

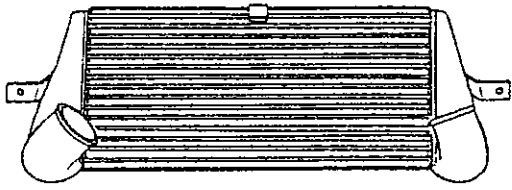

1



2

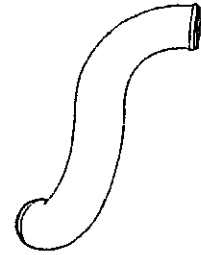

3

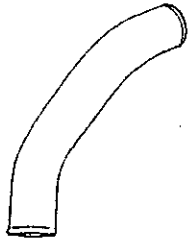

4

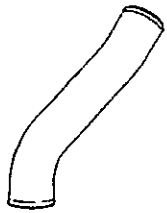

5

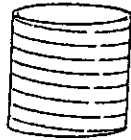

6



7

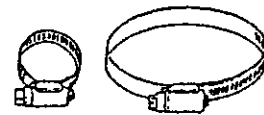

8~11



12



13

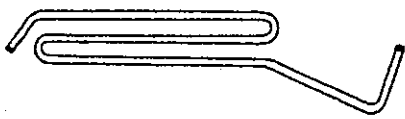

14

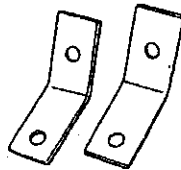

15

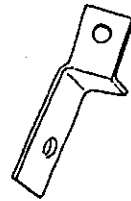

16

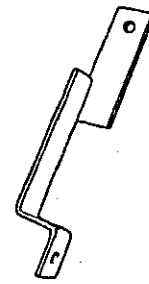

17



18



19



20

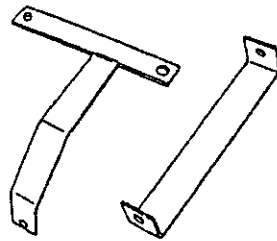

21



22



23

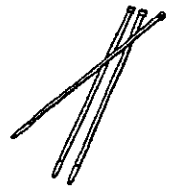

24

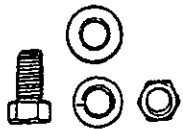

25~29

## 2. Removal of Stock Parts

When removing the stock parts, make sure you read over the factory repair manual for proper procedures.

2-1 Disconnect the negative side of the battery.

2-2 Remove the undercover, and drain the coolant.

(1) Remove the Airinx and the suction pipe.

(2) Remove the intercooler piping.

(3) Remove the intercooler.

(4) Unbolt the A/C fluid tank bracket.

(2) Remove the intercooler air duct.

(3) Disconnect the radiator fan.

(4) Unbolt the fuse relay box.

(5) Remove both the upper and lower radiator hose.

(6) Remove the radiator w/ fan.

(10) Drain the power steering fluid, and remove the power steering oil cooler tube.

### 3. Kit Installation

#### 3-7 Power Steering Cooler Installation

- (1) Bend the factory P/S cooler mounting bracket, (located in Fig. 1 with a circle) to the dotted line shown in Fig. 2

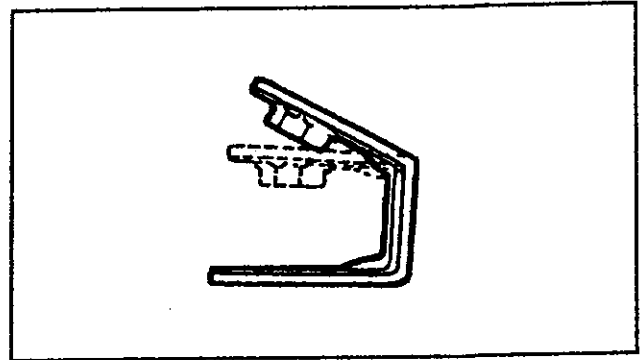
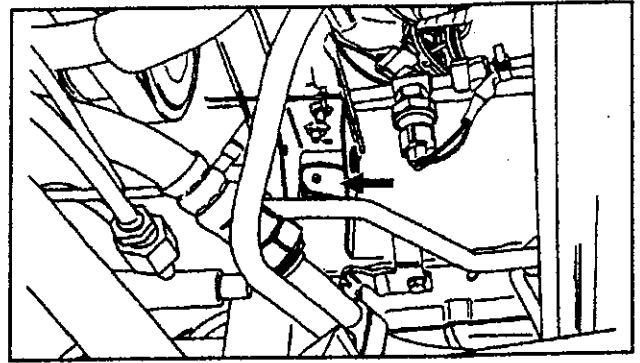

- (2) Bend two of the three provided P/S cooler tube brackets, 20° at 35mm from the bottom as shown in Fig. 3

(2 of Part #22)

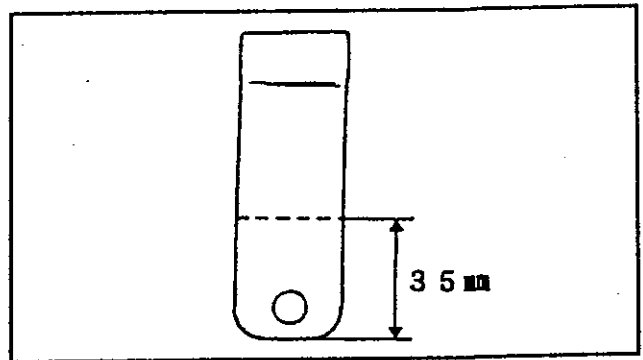

- (3) Mount the provided P/S cooler bracket.

- Use the two bent brackets from Step (2) at the arrow shown in Fig. 4

- Mount the third (unmodified P/S cooler) bracket onto the bracket you bent in Step (1) at Fig. 1  
[Use the factory hose clamp and bolts.]

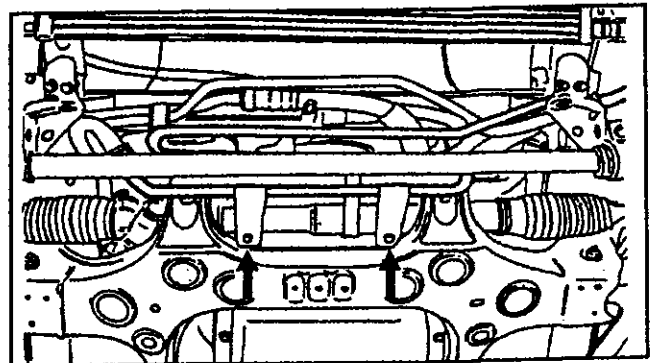

(1 of Part #22, Part #13)

### 3-8 Body Modification (1)

Cut the shaded area.

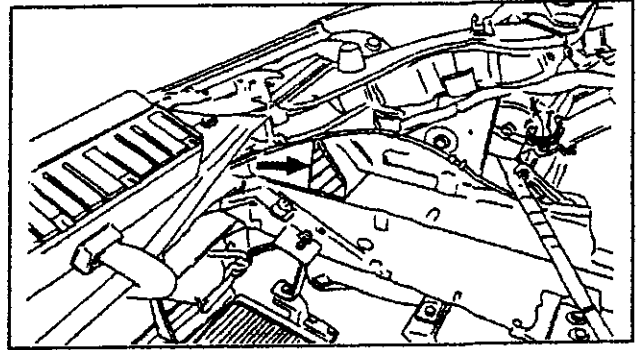

### 3-9 Body Modification (2)

Drill a 7mm hole in the lower radiator mounting bracket, as shown in Fig. 6

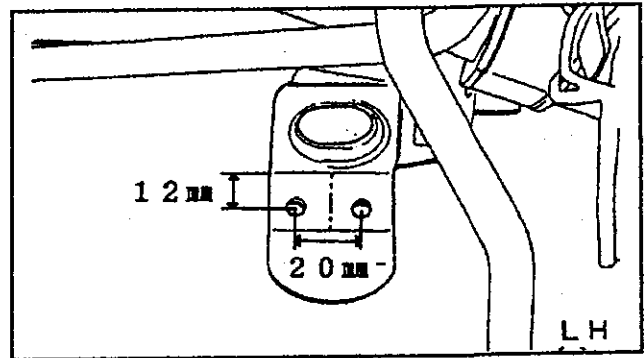
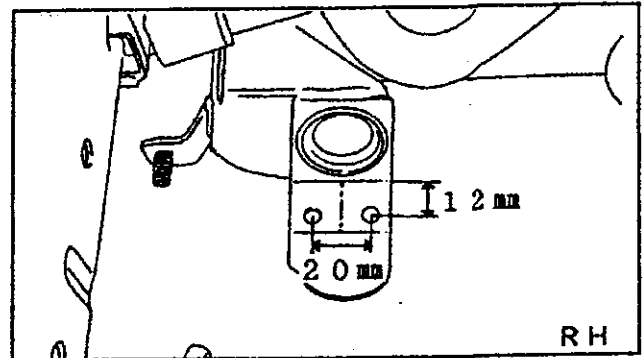

### 3-10 Lower Radiator Mounting Installation

Mount the provided radiator brackets to the lower radiator mounts.

(Part #s 19 & 25).

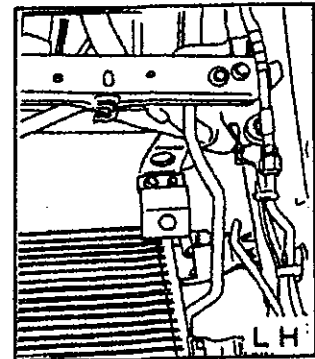
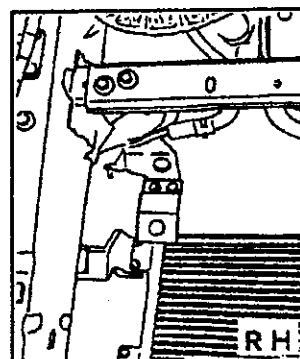

### 3-5 Radiator Installation

- (1) Remove the factory upper radiator mounting bracket shown (Left & Right)

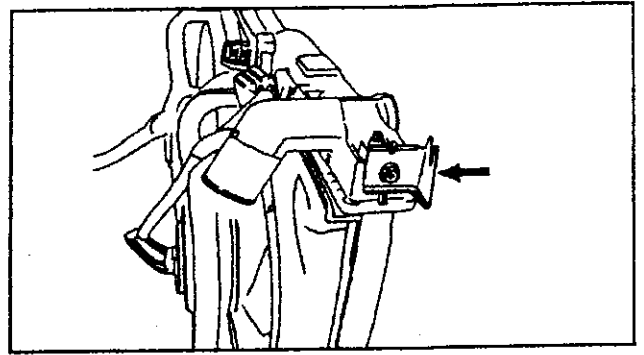

- (2) Remove the rubber mounts shown and mount it on to the same location as in the previous step. (Left & Right)

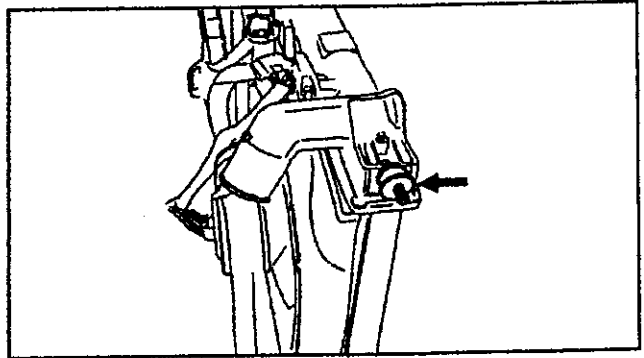
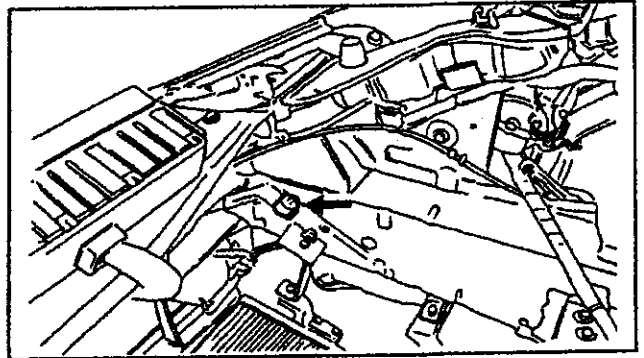

### 3-6 Radiator Installation (2)

Insert the pin on the bottom of the bracket installed in **Step 3-4**.  
Mount the top using brackets A & B with the factory nuts and bolts.

(Part #s 17, 18, & 26)

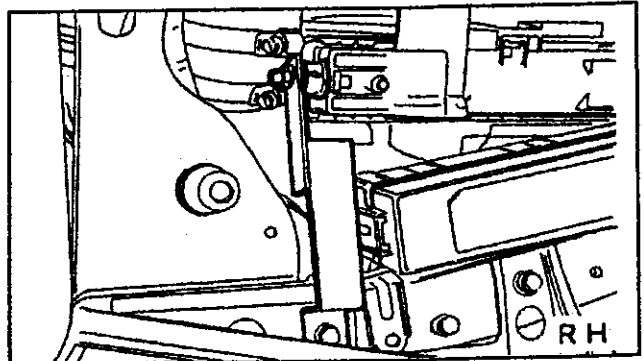



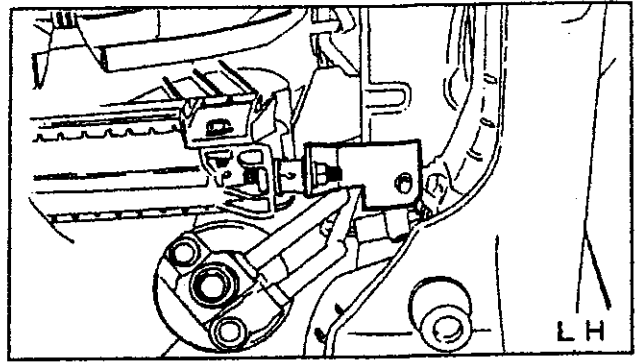

### 3-7 A/C Condenser Relocation

(1) Install the provided A/C condenser bracket "A" at the shown location.

(Part #s 15 & 26)

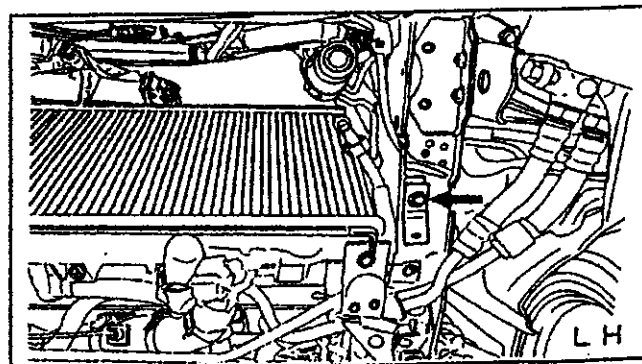
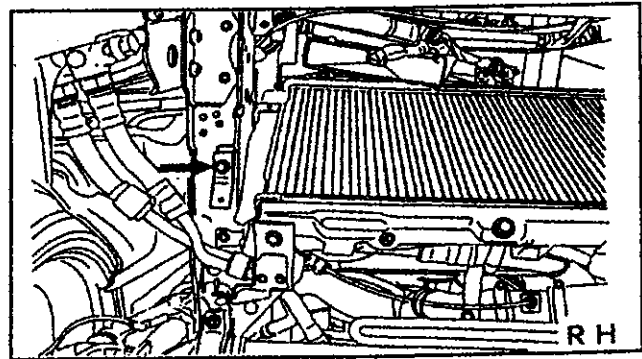
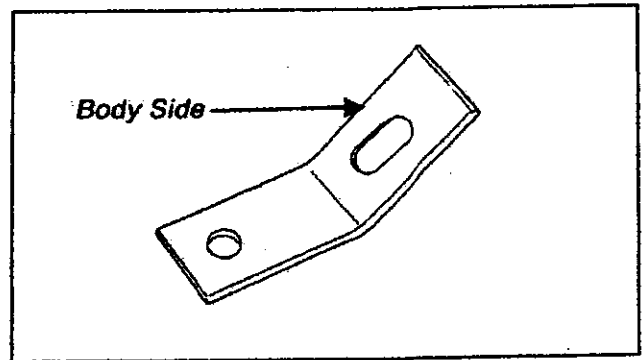

(2) Install the provided A/C condenser bracket "B" as shown.

(Part #s 16 & 26)

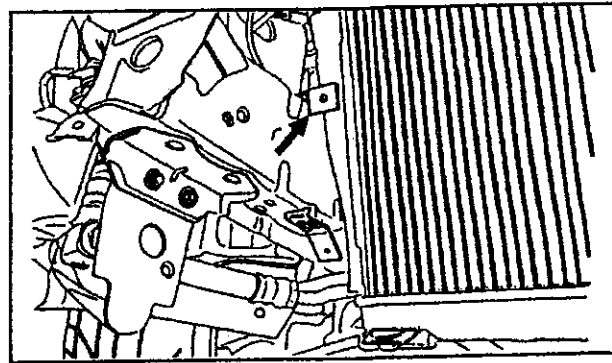
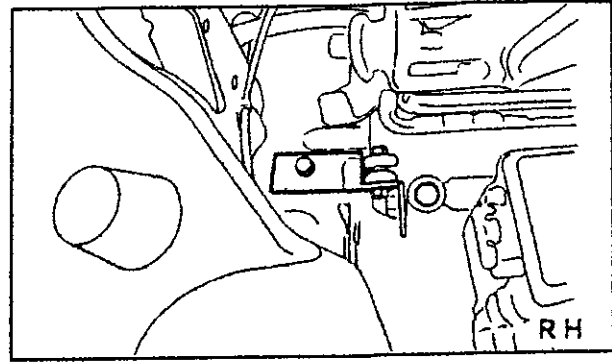

6 Mount the A/C condenser to the brackets.

(Part # 27)

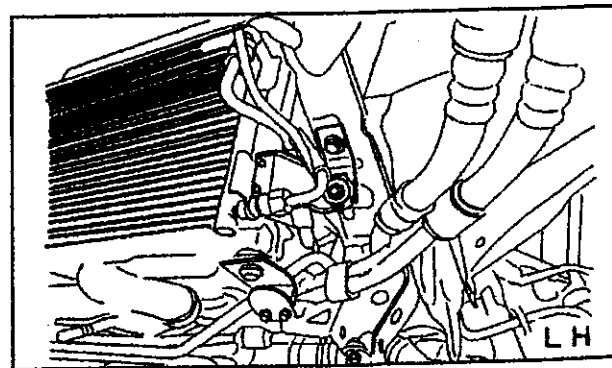
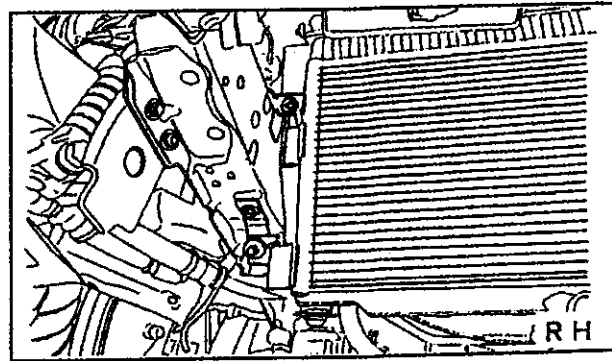

### 3-8 A/C Fluid Tank Bracket Modification

- (1) Cut the shaded area from the A/C fluid tank bracket.

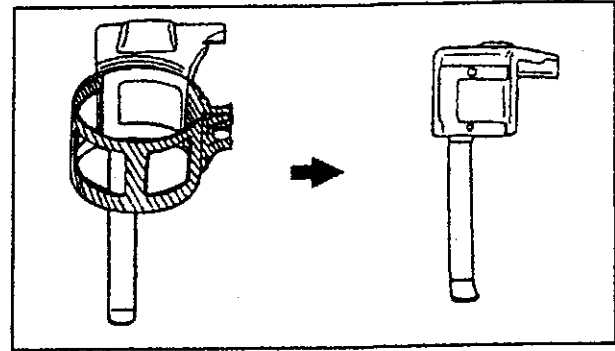

- (2) Slot the mounting hole as shown.

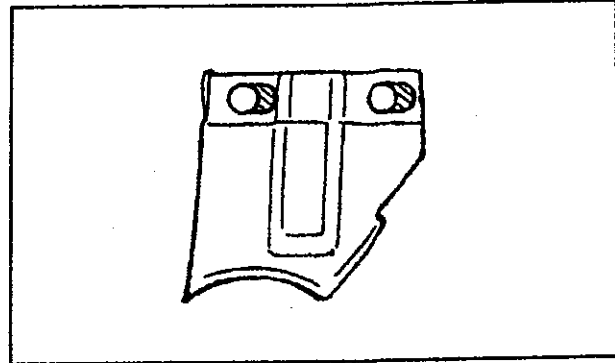

- (3) Mounting the A/C Fluid Tank Bracket

Mount the A/C tank to the modified bracket with a hose band. Then mount to the body.

(Part # 9)

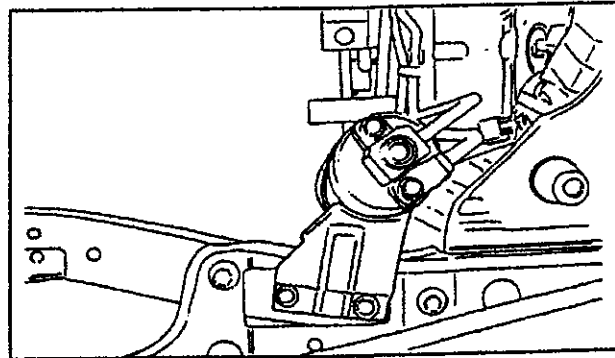

### 3-9 Radiator Hose Modification

- (1) Cut the upper radiator hose as shown.

\*The parts indicated with the arrows are the segments that will be used.

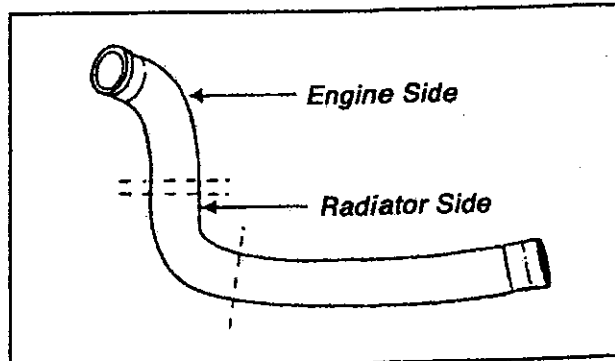

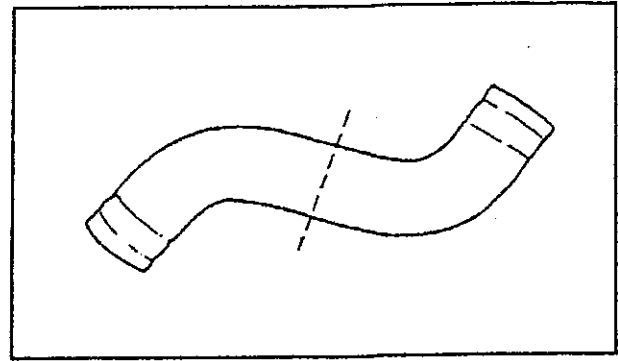

- (2) Install the cut radiator hose using the water tube provided.

\*Figure shows the upper hose using the water tube

(Part #s 8, 12, & 13)

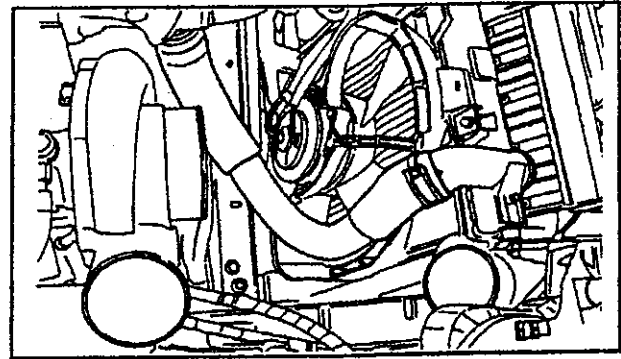

### 3-10 Battery Tray Modification

- (1) Cut the battery tray to the specified dimension.  
Drill a 7mm hole in the tray at the location indicated by the arrow.

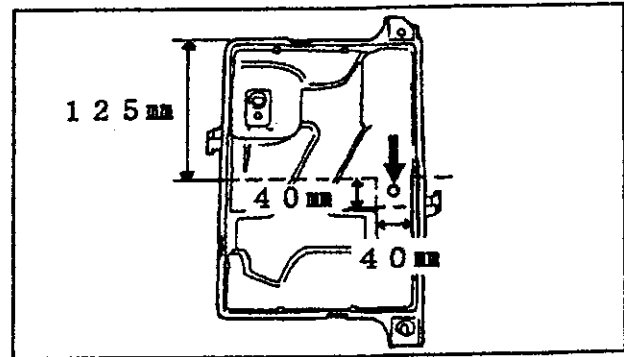

- (2) Place the battery bracket under the tray as shown and mount the tray in the factory location.

(Part # 21)

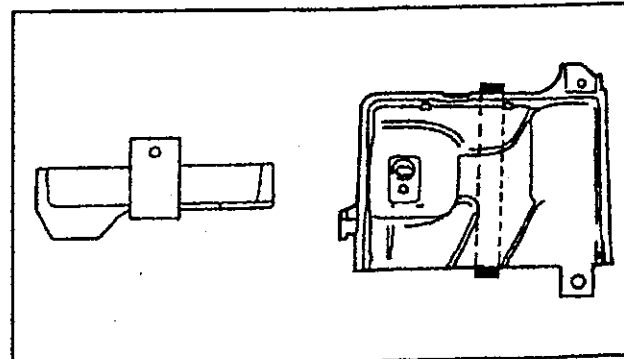

- (3) At points labeled "A" & "B" use factory bolts. At "C" use provided tapping screws

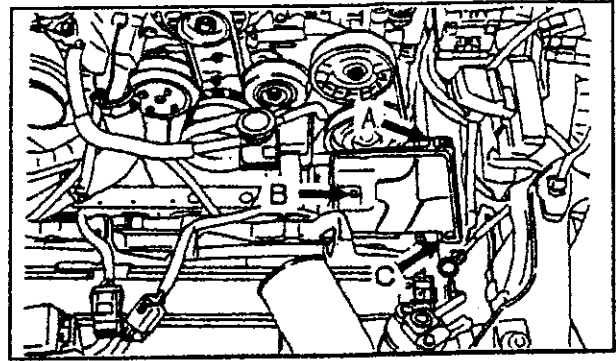

### 3-11 Battery Installation

Position the battery on the tray. Using the battery bracket and the factory mounting rod, secure the battery in place.  
Mount the air separator tank on to the bracket.

(Part # 21)

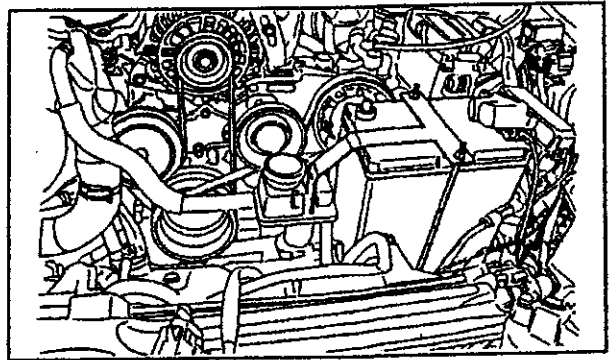

### 3-12 Body Modification (3)

Cut the shaded area below the reinforcement as shown.

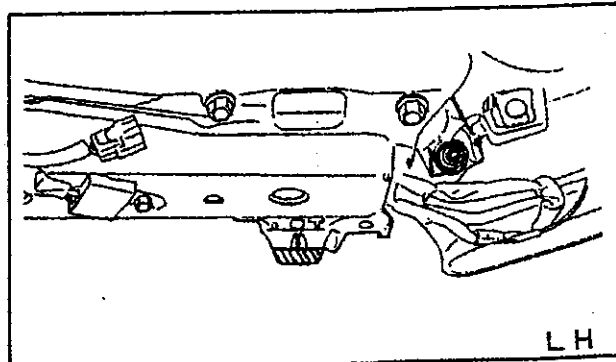
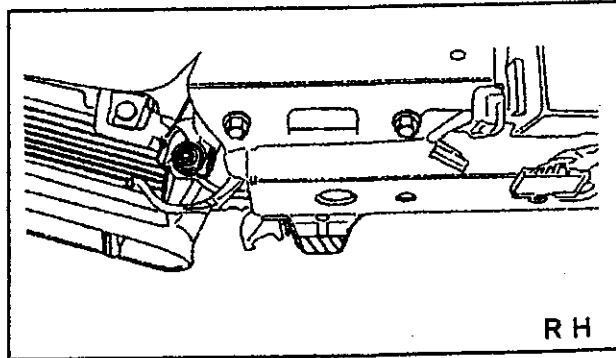

### 3-13 Intercooler Installation

- (1) Remove the rivets on the bumper reinforcement as shown.

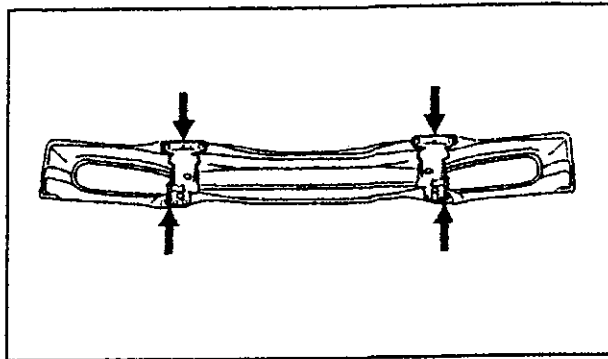

- (3) Cut the bumper reinforcement as shown.

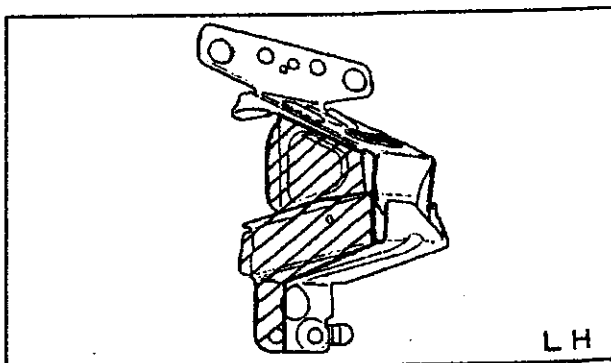
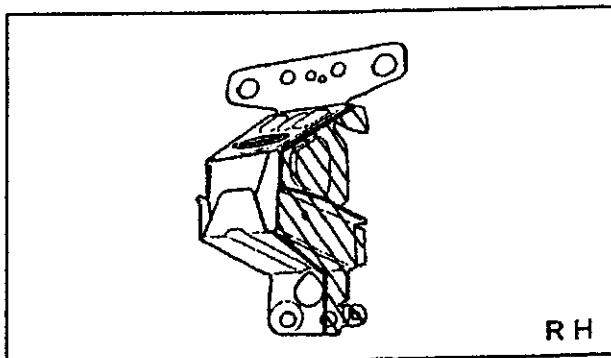
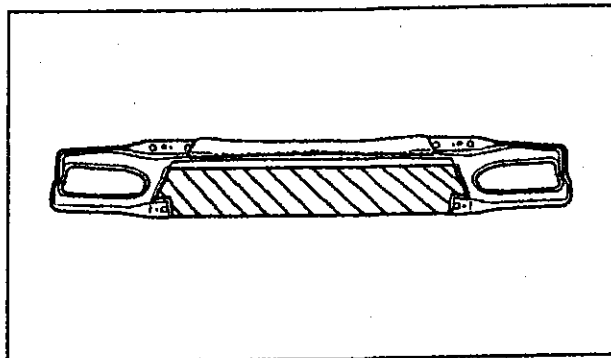

(3) Mount the top intercooler bracket to the hood lock racket as shown.

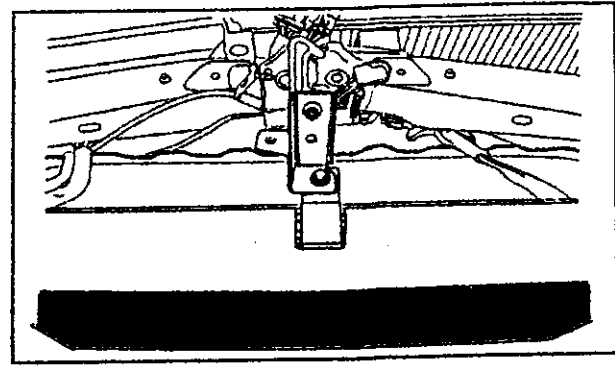

(4) Mount the side bracket with the modified bumper reinforcement as shown.

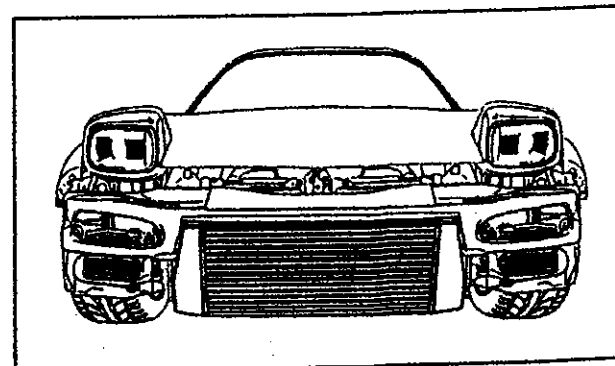
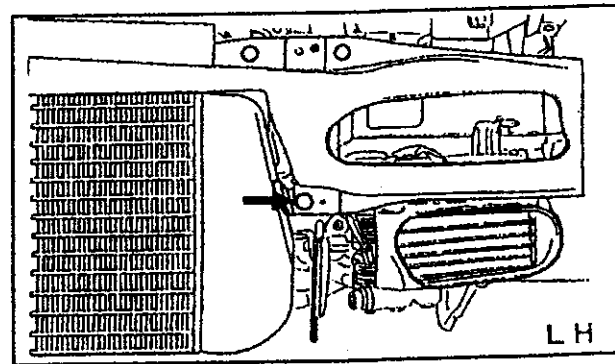
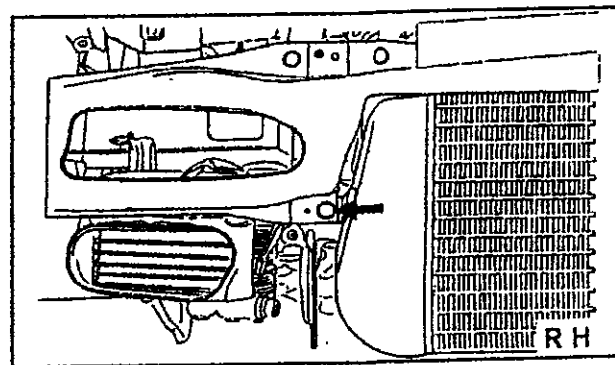

### 3-14 Intake Tube Installation (1)

Install the intake tubes I-1 and I-2 as shown.

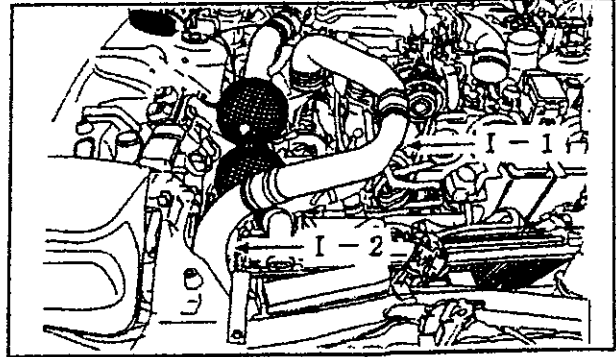

### 3-15 Intake Tube Installation (2)

Install intake tubes I-3 and I-4 as shown.

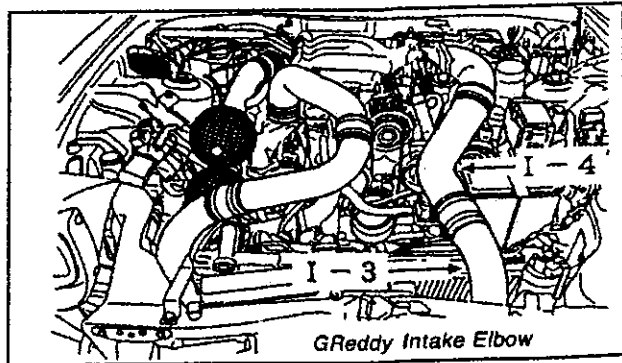
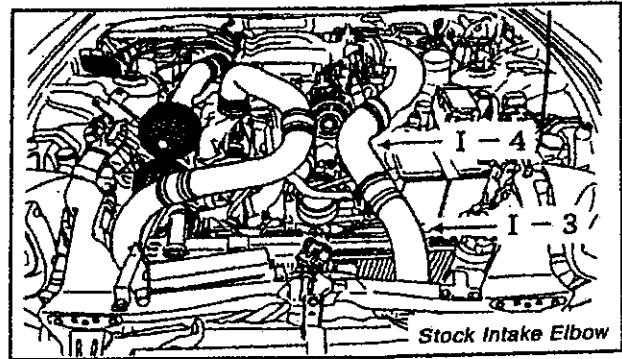

### 3-16 Fuse Relay Box Install

Re-install the fuse relay box using the provided aluminum spacer and connect the radiator fan.

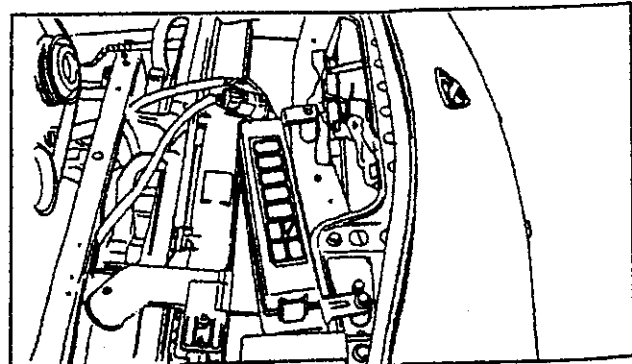



### 3-17 Undercover Modification

Cut out the shaded area as shown.

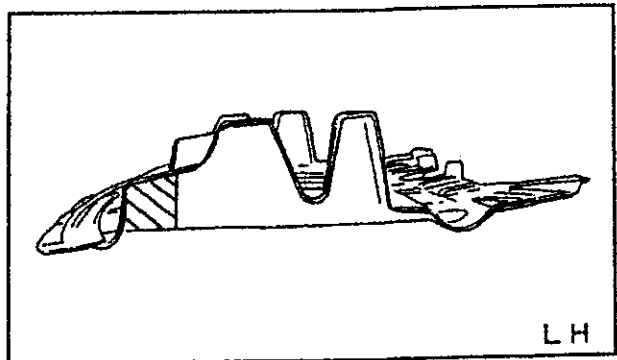
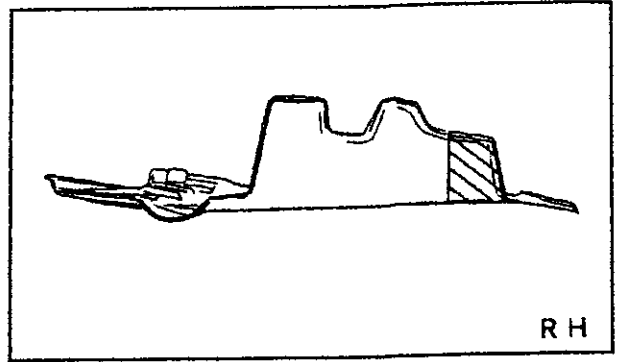

### 3-18 Battery Terminal Modification

Cut the positive side connector tab as shown.

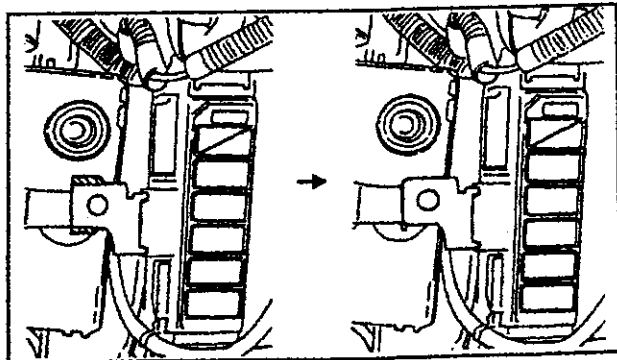

### 3-19 Battery Terminal Installation

Connect the terminal as shown. Use the provided battery terminal spacer.

(Part # 23)

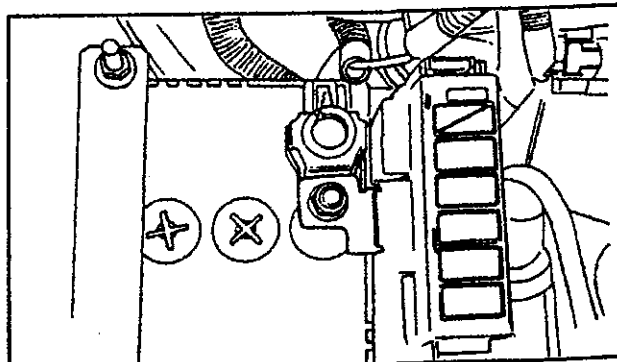

### **3-22 Before Starting the Engine:**

- (1) Refill the coolant.
- (2) Refill the power steering fluid.
- (3) Make sure the power steering fluid is completely filled by turning the steering wheel left and right.
- (4) Connect the (-) terminal of the battery.
- (5) Check to see if all of the harnesses and piping are secure.
- (6) Crank the engine, without starting it, to build up oil pressure.
- (7) Start the engine and check for any oil, water or air leaks.

### 3-23 How to Get Air Out of the Power Steering

- (1) While the car is idling, turn the steering wheel all the way to the left, then turn the steering wheel all the way to the right. Continue this process until the fluid stops bubbling.
- (2) Refill the P/S fluid to the proper fluid level indicated on the P/S fill tank.

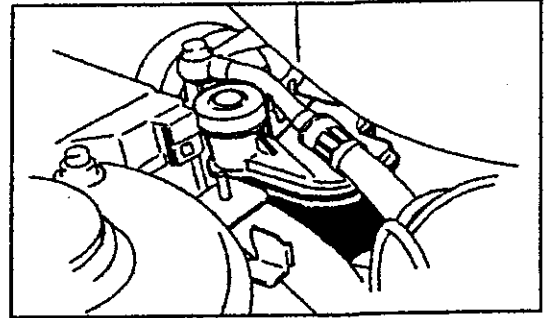
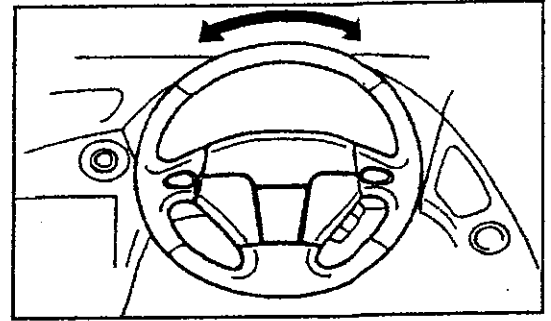

### 3-23 Undercover Installation

Install the modified undercover, from Step 3-17.

### This completes the Installation of the GReddy Intercooler Kit for the FD3S

Due to the relocation of the A/C condenser, there is the possibility that the A/C may not be as efficient as with the condenser in the factory location.

To improve the efficiency, it is recommended to install an electric fan.

This figure shows an ideal installation of an electric fan that still allows the undercover to be used.

